

Title		
<Title>		
Size	Document Number	Rev
A	<Doc>	<RevCode>
Date:	Wednesday, January 06, 2021	Sheet 1 of 3

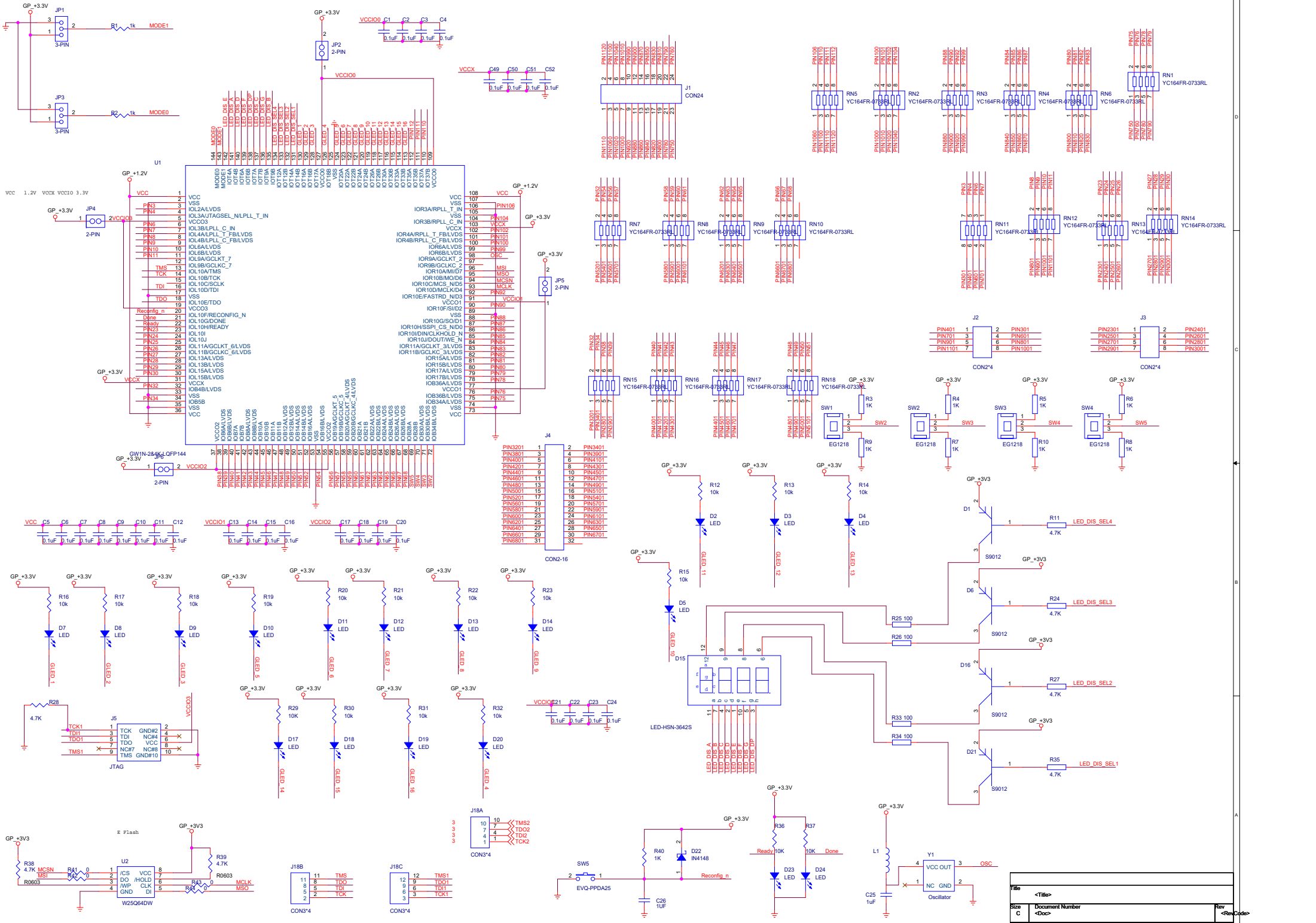

144 MODE0

144	MODE0	LED_DS_E
143	MODE1	LED_DS_A
142	MODE2	LED_DS_B
141	MODE3	LED_DS_C
140	MODE4	LED_DS_D
139	MODE5	LED_DS_F
138	MODE6	LED_DS_G
137	MODE7	LED_DS_H
136	MODE8	LED_DS_I
135	MODE9	LED_DS_J
134	MODE10	LED_DS_K
133	MODE11	LED_DS_L
132	MODE12	LED_DS_M
131	MODE13	LED_DS_N
130	MODE14	LED_DS_O
129	MODE15	LED_DS_P
128	MODE16	LED_DS_Q
127	MODE17	LED_DS_R
126	MODE18	LED_DS_S
125	MODE19	LED_DS_T
124	MODE20	LED_DS_U
123	MODE21	LED_DS_V
122	MODE22	LED_DS_W
121	MODE23	LED_DS_X
120	MODE24	LED_DS_Y
119	MODE25	LED_DS_Z
118	MODE26	LED_DS_0
117	MODE27	LED_DS_1
116	MODE28	LED_DS_2
115	MODE29	LED_DS_3
114	MODE30	LED_DS_4
113	MODE31	LED_DS_5
112	MODE32	LED_DS_6
111	MODE33	LED_DS_7
110	MODE34	LED_DS_8
109	MODE35	LED_DS_9
108	MODE36	LED_DS_10
107	MODE37	LED_DS_11
106	MODE38	LED_DS_12
105	MODE39	LED_DS_13
104	MODE40	LED_DS_14
103	MODE41	LED_DS_15
102	MODE42	LED_DS_16
101	MODE43	LED_DS_17
100	MODE44	LED_DS_18
99	MODE45	LED_DS_19
98	MODE46	LED_DS_20
97	MODE47	LED_DS_21
96	MODE48	LED_DS_22
95	MODE49	LED_DS_23
94	MODE50	LED_DS_24
93	MODE51	LED_DS_25
92	MODE52	LED_DS_26
91	MODE53	LED_DS_27
90	MODE54	LED_DS_28
89	MODE55	LED_DS_29
88	MODE56	LED_DS_30
87	MODE57	LED_DS_31
86	MODE58	LED_DS_32
85	MODE59	LED_DS_33
84	MODE60	LED_DS_34
83	MODE61	LED_DS_35
82	MODE62	LED_DS_36
81	MODE63	LED_DS_37
80	MODE64	LED_DS_38
79	MODE65	LED_DS_39
78	MODE66	LED_DS_40
77	MODE67	LED_DS_41
76	MODE68	LED_DS_42
75	MODE69	LED_DS_43
74	MODE70	LED_DS_44
73	MODE71	LED_DS_45
72	MODE72	LED_DS_46
71	MODE73	LED_DS_47
70	MODE74	LED_DS_48
69	MODE75	LED_DS_49
68	MODE76	LED_DS_50
67	MODE77	LED_DS_51
66	MODE78	LED_DS_52
65	MODE79	LED_DS_53
64	MODE80	LED_DS_54
63	MODE81	LED_DS_55
62	MODE82	LED_DS_56
61	MODE83	LED_DS_57
60	MODE84	LED_DS_58
59	MODE85	LED_DS_59
58	MODE86	LED_DS_60
57	MODE87	LED_DS_61
56	MODE88	LED_DS_62
55	MODE89	LED_DS_63
54	MODE90	LED_DS_64
53	MODE91	LED_DS_65
52	MODE92	LED_DS_66
51	MODE93	LED_DS_67
50	MODE94	LED_DS_68
49	MODE95	LED_DS_69
48	MODE96	LED_DS_70
47	MODE97	LED_DS_71
46	MODE98	LED_DS_72
45	MODE99	LED_DS_73
44	MODE100	LED_DS_74
43	MODE101	LED_DS_75
42	MODE102	LED_DS_76
41	MODE103	LED_DS_77
40	MODE104	LED_DS_78
39	MODE105	LED_DS_79
38	MODE106	LED_DS_80
37	MODE107	LED_DS_81
36	MODE108	LED_DS_82
35	MODE109	LED_DS_83
34	MODE110	LED_DS_84
33	MODE111	LED_DS_85
32	MODE112	LED_DS_86
31	MODE113	LED_DS_87
30	MODE114	LED_DS_88
29	MODE115	LED_DS_89
28	MODE116	LED_DS_90
27	MODE117	LED_DS_91
26	MODE118	LED_DS_92
25	MODE119	LED_DS_93
24	MODE120	LED_DS_94
23	MODE121	LED_DS_95
22	MODE122	LED_DS_96
21	MODE123	LED_DS_97
20	MODE124	LED_DS_98
19	MODE125	LED_DS_99
18	MODE126	LED_DS_100
17	MODE127	LED_DS_101
16	MODE128	LED_DS_102
15	MODE129	LED_DS_103
14	MODE130	LED_DS_104
13	MODE131	LED_DS_105
12	MODE132	LED_DS_106
11	MODE133	LED_DS_107
10	MODE134	LED_DS_108
9	MODE135	LED_DS_109
8	MODE136	LED_DS_110
7	MODE137	LED_DS_111
6	MODE138	LED_DS_112
5	MODE139	LED_DS_113
4	MODE140	LED_DS_114
3	MODE141	LED_DS_115
2	MODE142	LED_DS_116
1	MODE143	LED_DS_117
0	MODE144	LED_DS_118

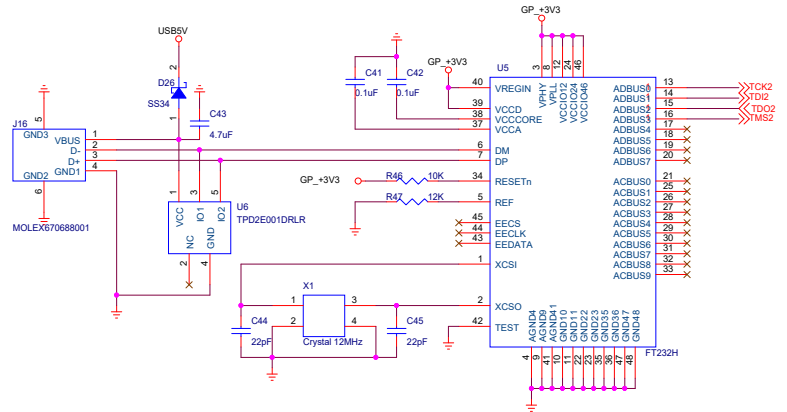
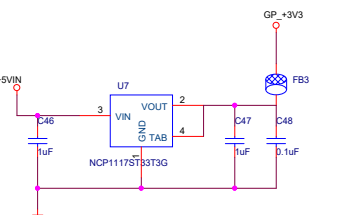
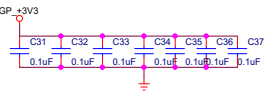
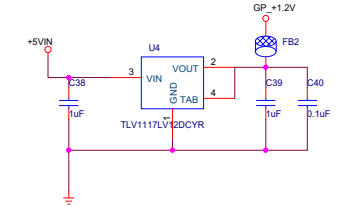
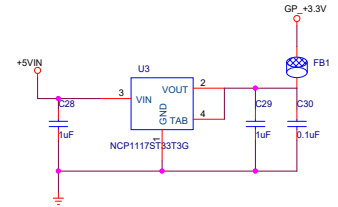
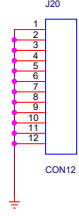
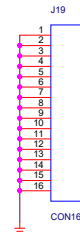
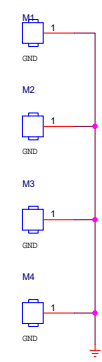
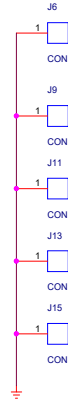
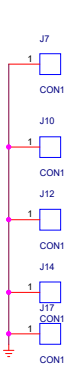
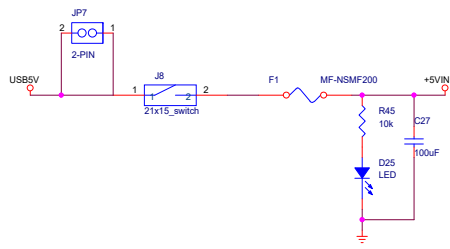

File	<Title>	
Size	Document Number	Rev
C	<Doc>	<Rev Code>
Date:	Wednesday, January 06, 2021	Sheet 3 of 3