

5

4

3

2

1

SCHEMATIC	CONTENT	PAGE
Power	5V, 3.3V, 2.5V, 1.5V, 1.2V, 1.0V, 0.75V	3
Bank Power	Bank 0_1 : 2.5V Bank 2_3 : 3.3V Bank 4_5_6 : 1.5V Bank 7 : ADJ (3.3V, 2.5V, 1.2V)	4
Bank0_1	LVDS, GPIO-2.5V, CLK, LED	5
Bank2	PHY1, JTAG, SMA	6
Bank3	PHY2, Flash, SD Card, MODE, DONE, RECONFIG, READY, RST	7
Bank4_5_6	DDR3, KEY, SW	8
Bank7	GPIO_3.3V, Backup Power	9

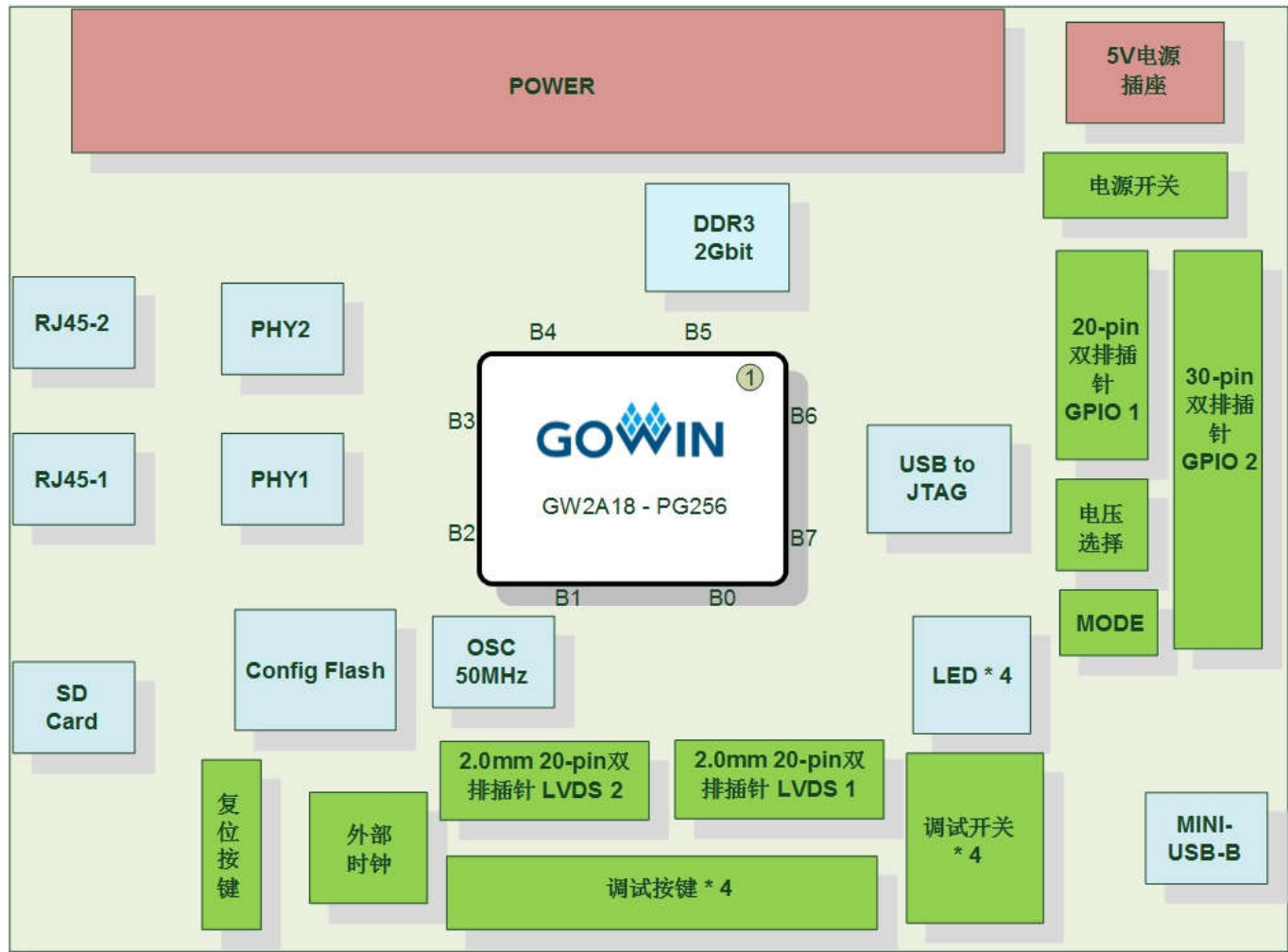

5 4 3 2 1

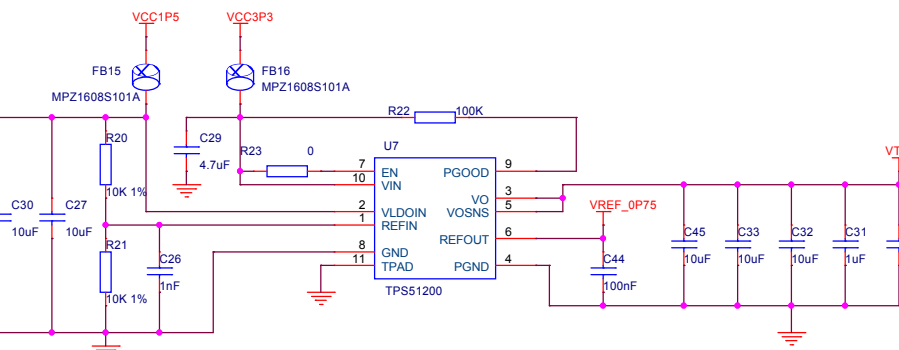
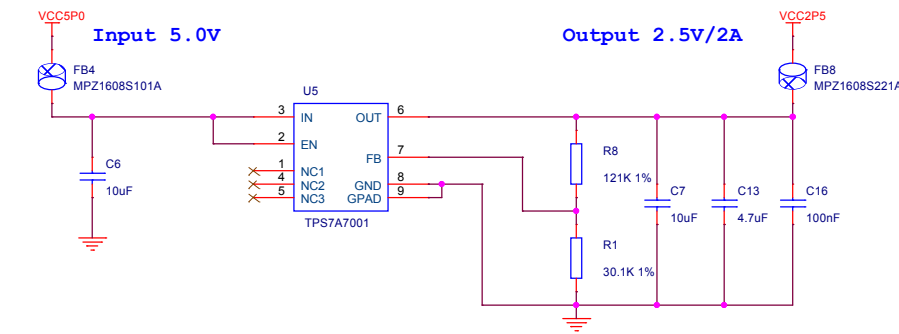
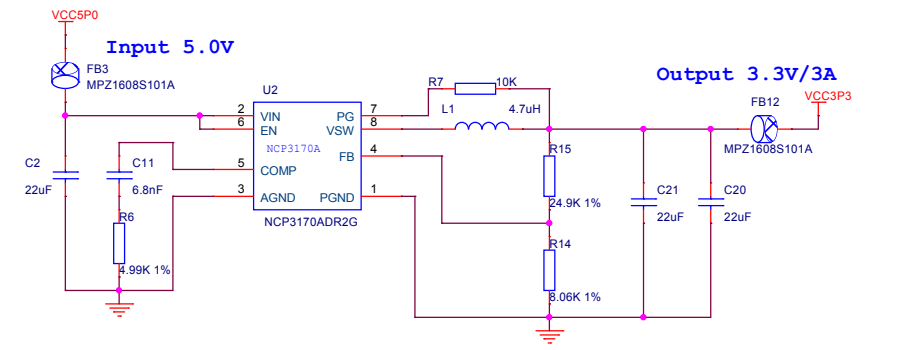
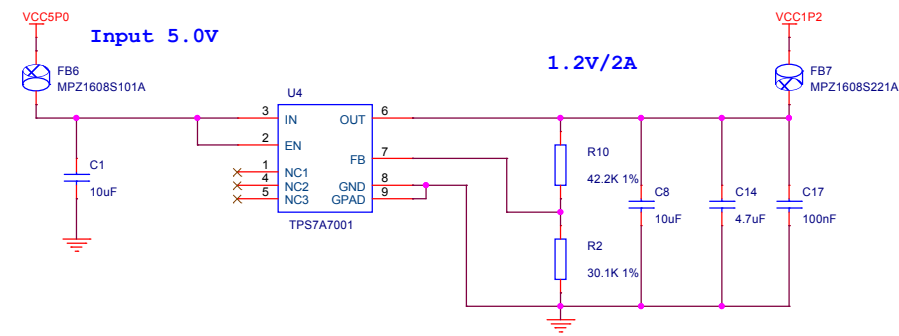
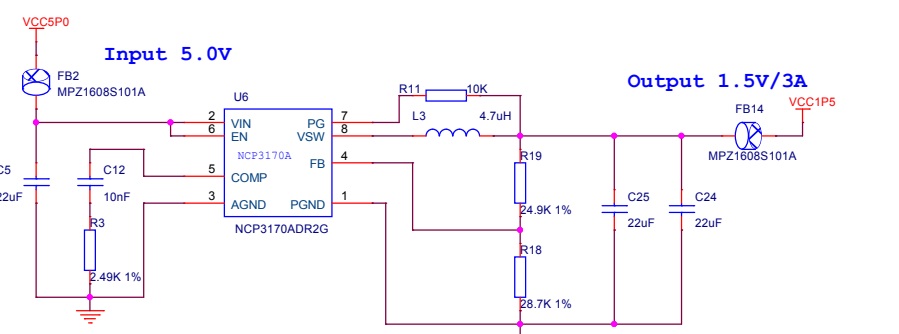
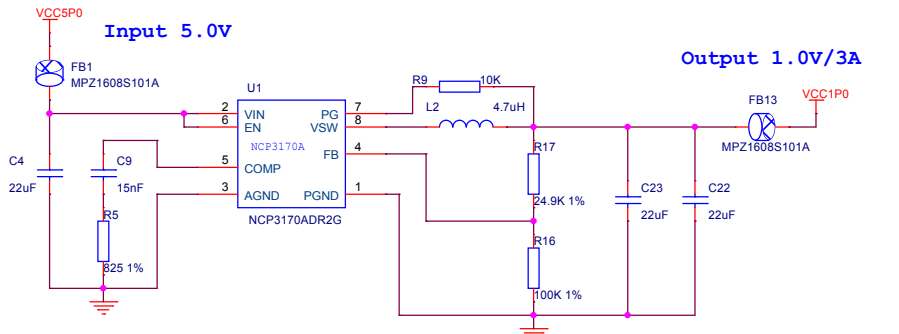
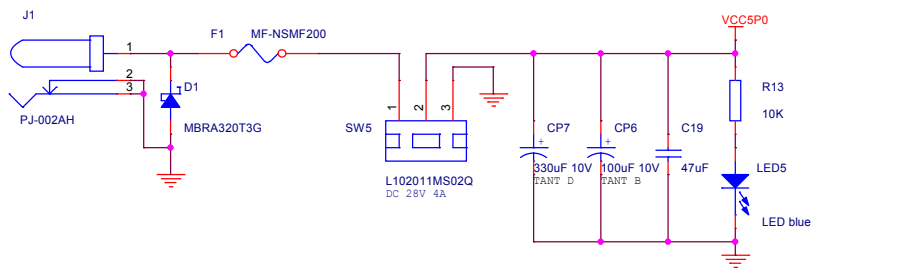

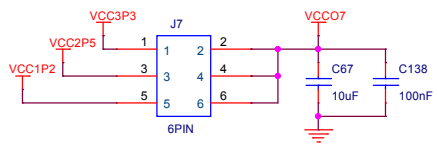
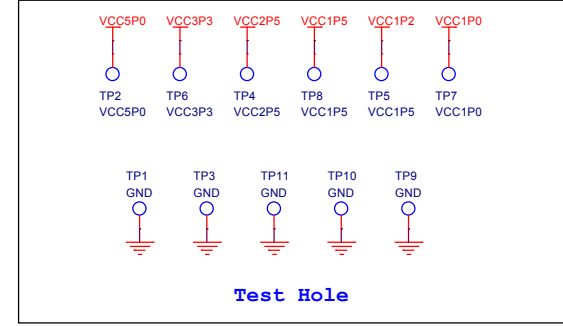
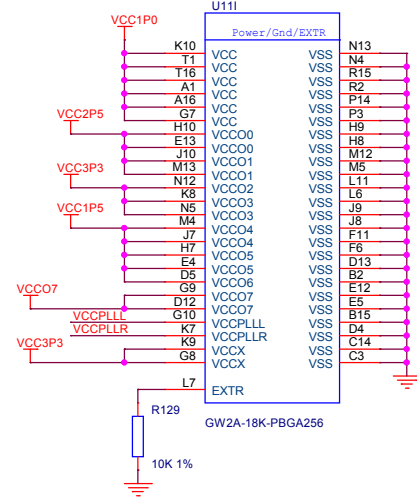
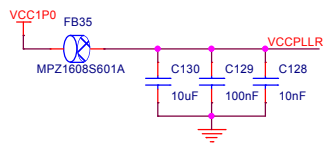
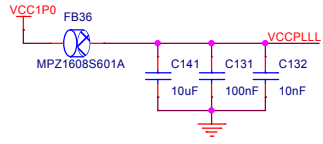

bank7电压可调

根据实际情况增减

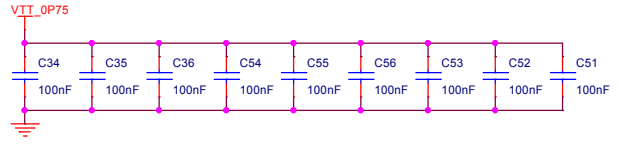
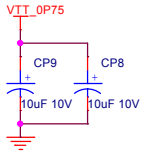
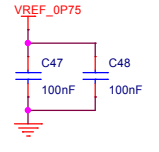
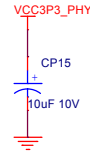
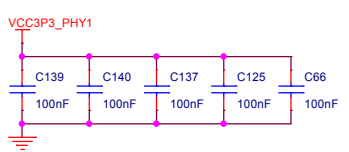
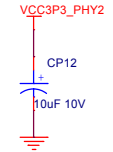
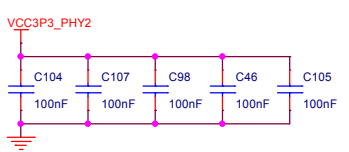
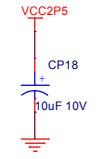
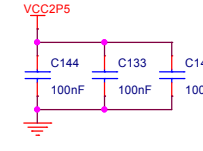
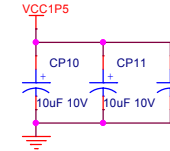
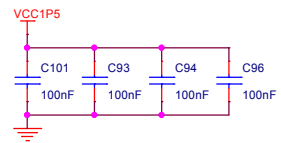
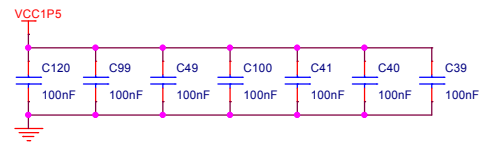
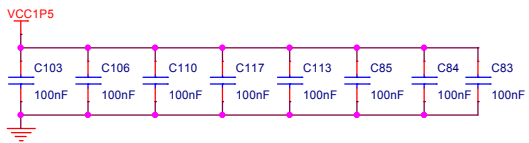
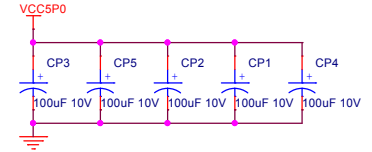
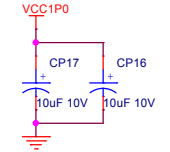
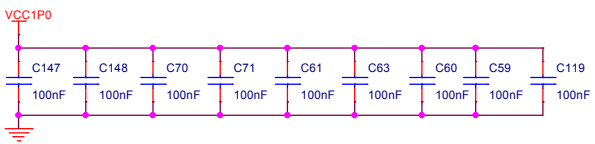
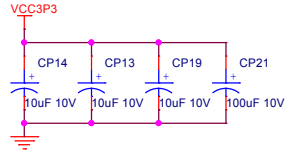
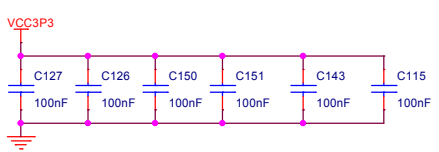

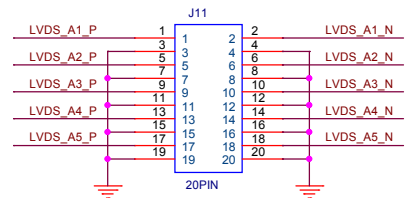

2mm间距, 无框插针, RX

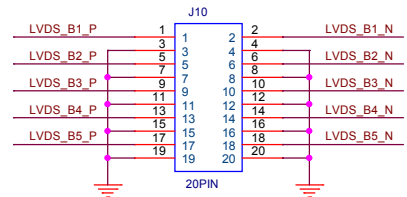

2mm间距, 无框插针, TX

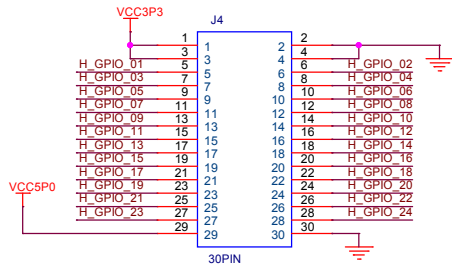

2.54mm间距, 无框插针

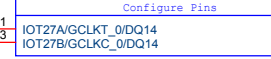
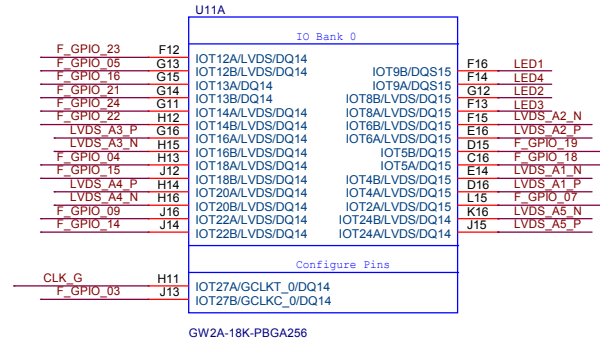
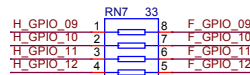
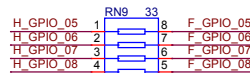
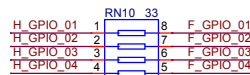
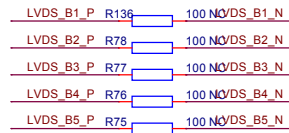
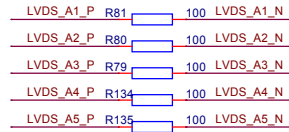
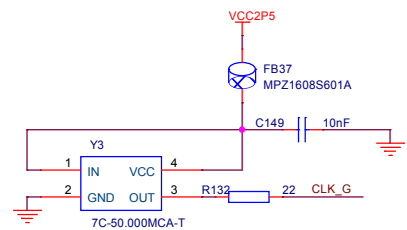

GW2A-18K-PBGA256

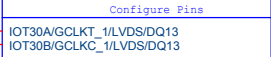
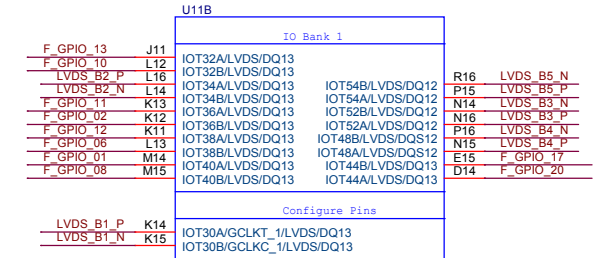

GW2A-18K-PBGA256

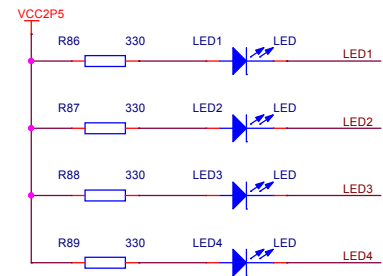
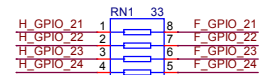
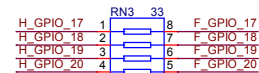
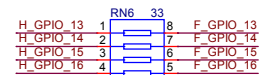

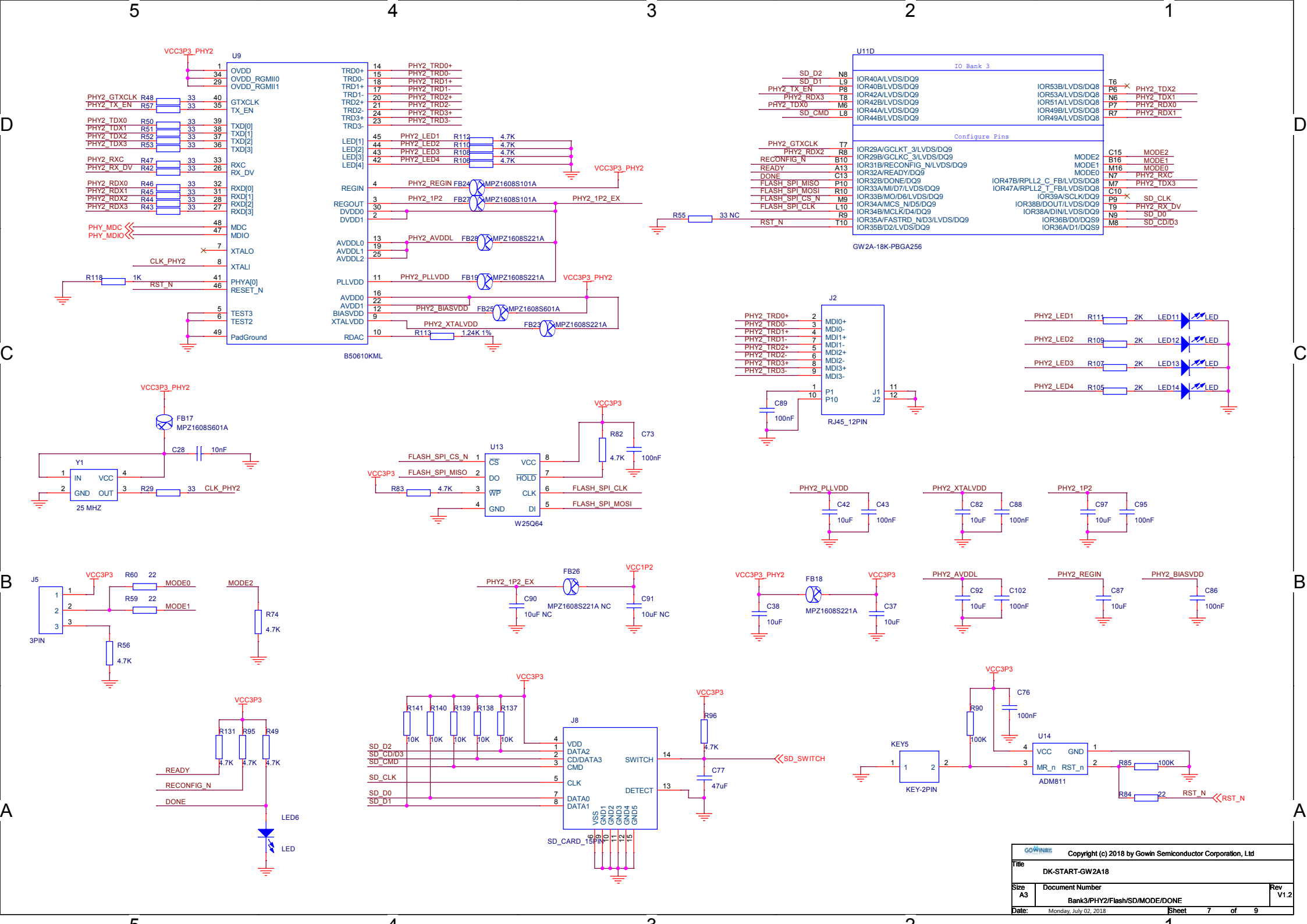

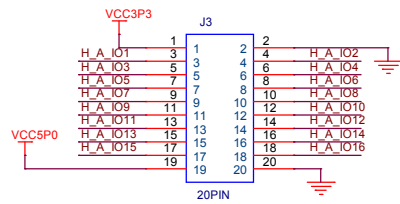

2.54mm间距，无框插针

