

SCHEMATIC	CONTENT	PAGE
Power	5V, 3.3V, 2.5V, 1.5V, 1.2V, 1.0V, 0.75V	3
Bank Power	Bank 0_1 : ADJ (3.3V, 2.5V) Bank 2_3 : 3.3V Bank 4_5_6 : 1.5V Bank 7 : ADJ (3.3V, 2.5V, 1.2V)	4
Bank0_1	LVDS, GPIO, CLK, LED	5
Bank2	PHY1, JTAG, SMA	6
Bank3	PHY2, Flash, SD Card, MODE, DONE, RECONFIG, READY, RST	7
Bank4_5_6	DDR3, KEY, SW	8
Bank7	GPIO_3.3V, Backup Power	9

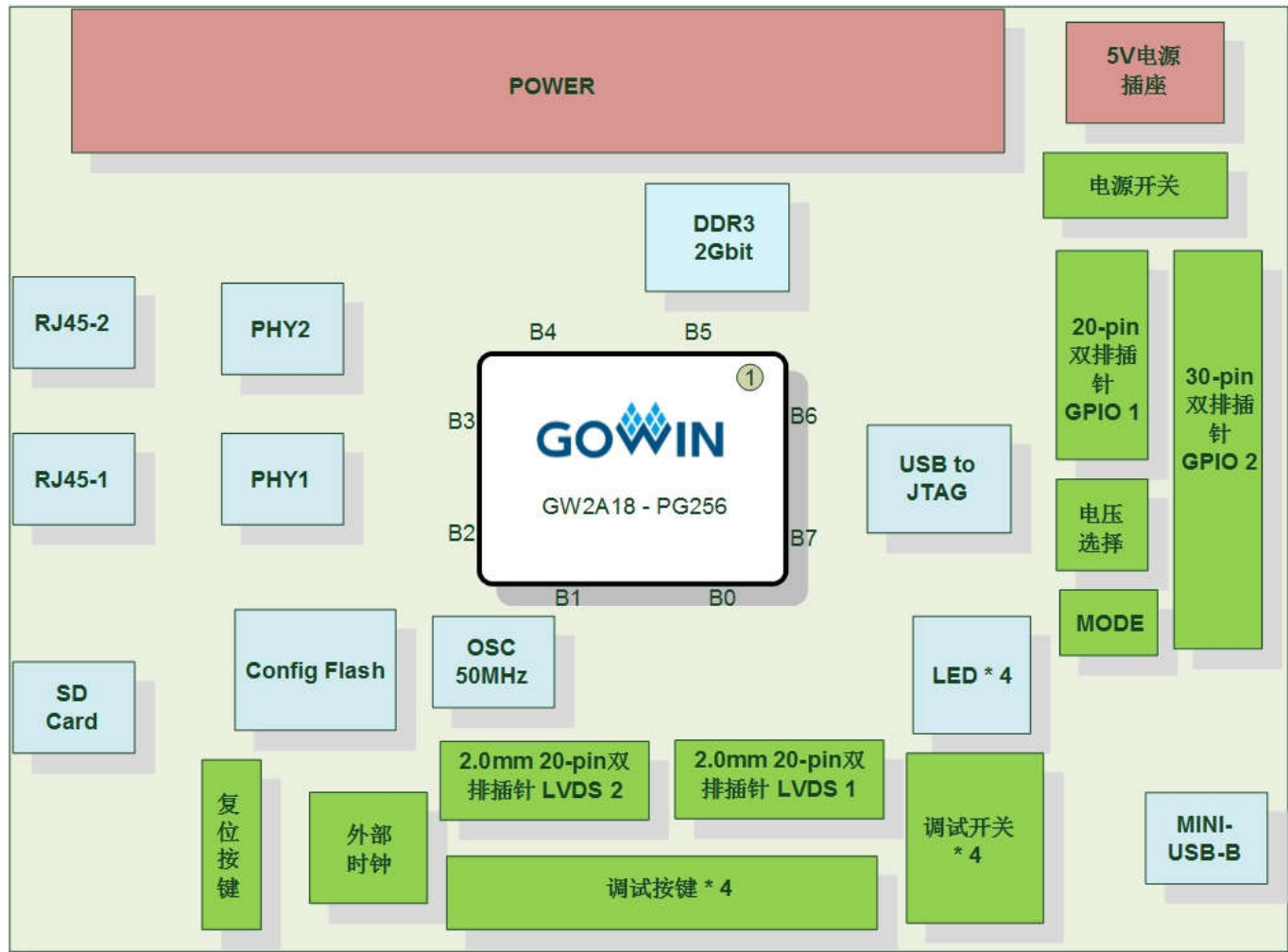

5

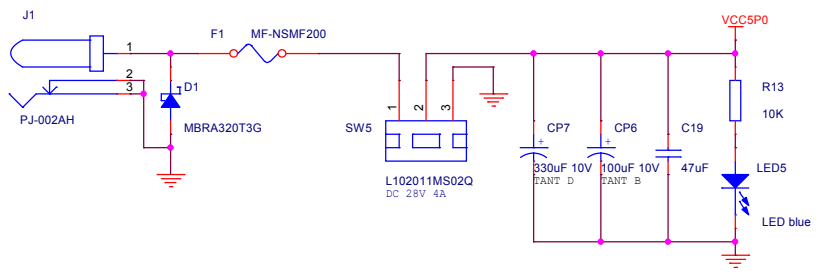

4

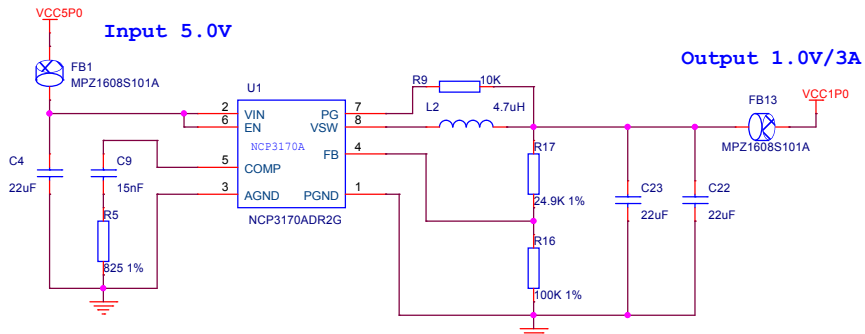

3

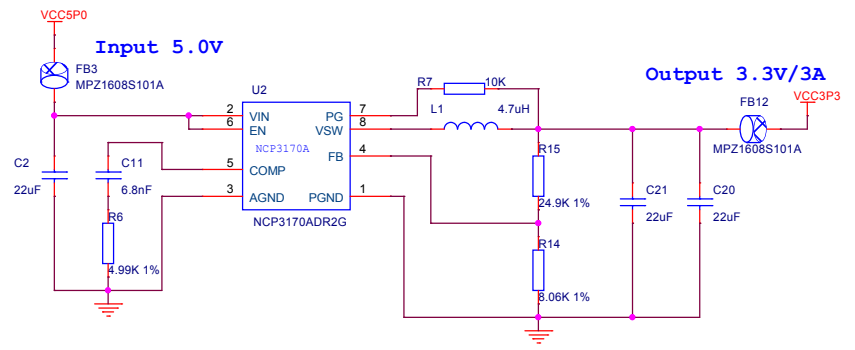

2

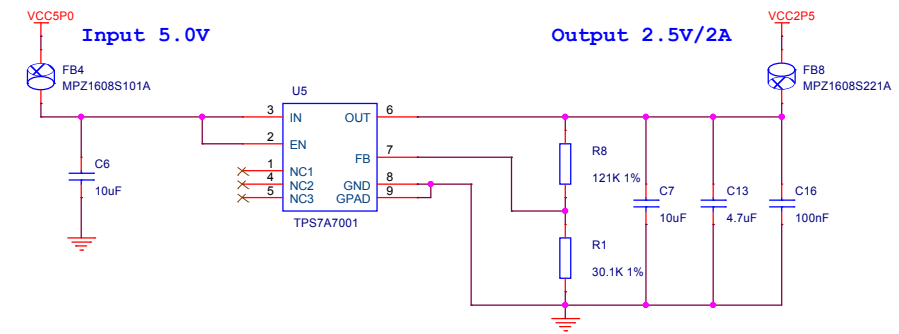

1

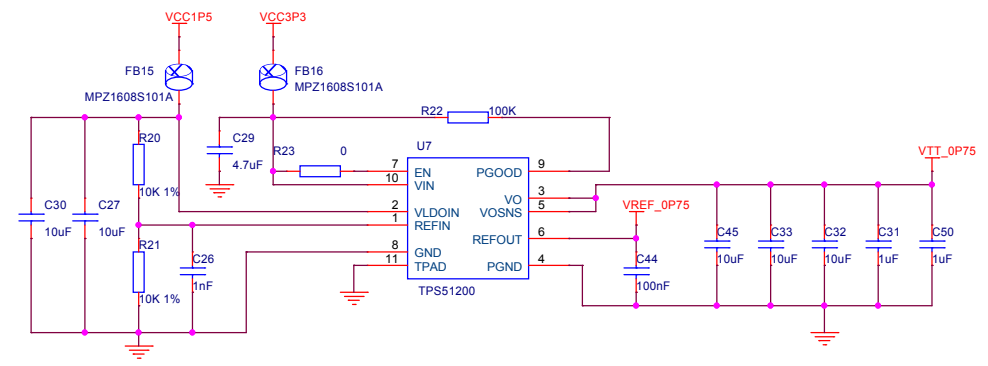

D

C

B

A

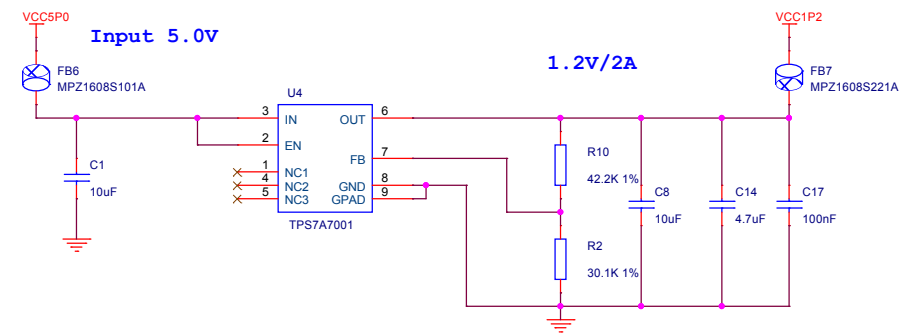

Copyright (c) 2018 by Gowin Semiconductor Corporation, Ltd			
DK-START-GW2A18			
Size A3	Document Number	Rev V2.0	
Date:	Friday, September 07, 2018	Sheet 3	of 9

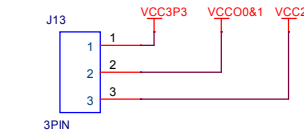
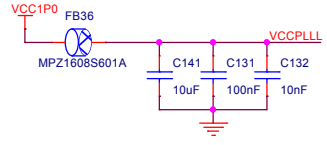

Bank0 和 Bank1 电压可调

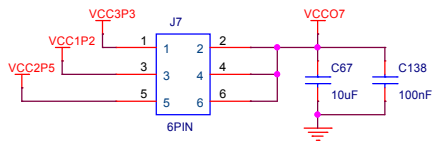
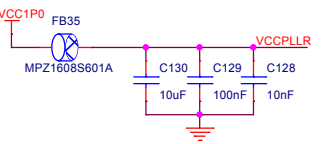
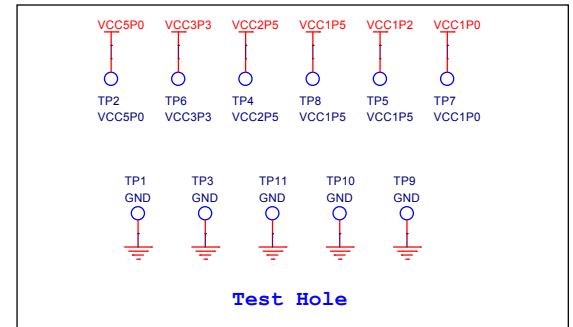
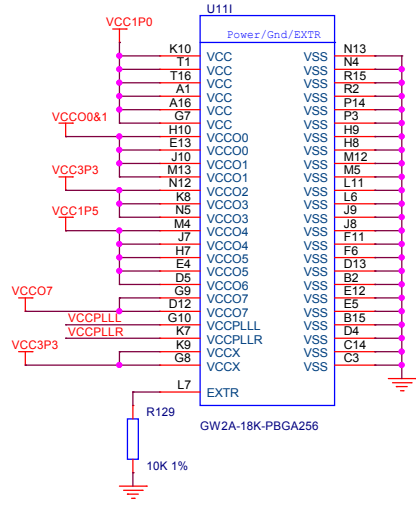

Bank7电压可调

根据实际情况增减

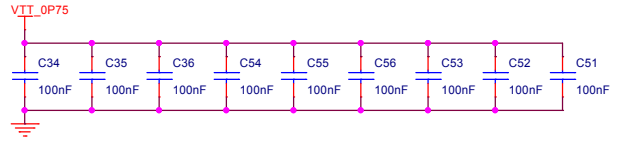
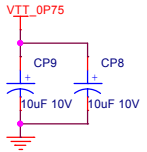
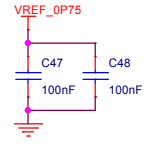
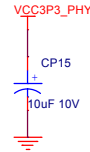
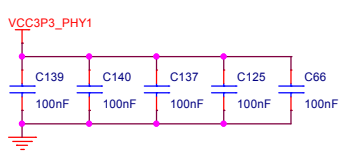
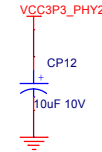
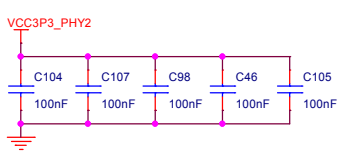
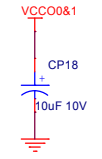
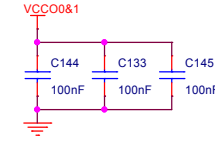
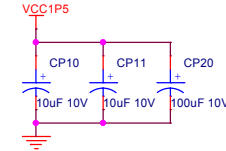
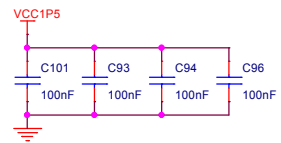
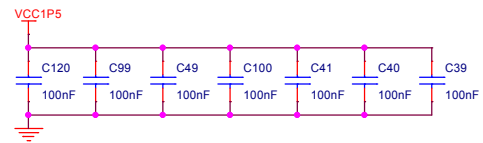
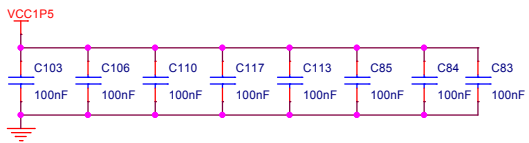
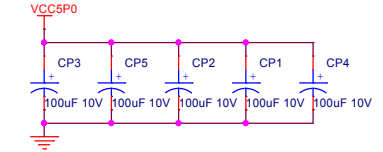
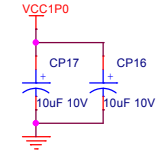
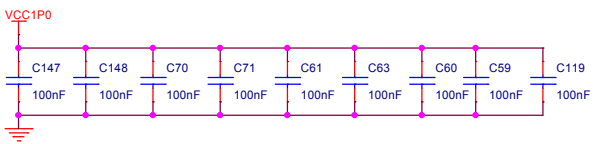
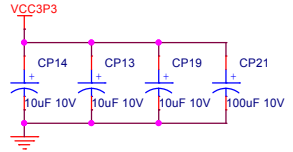
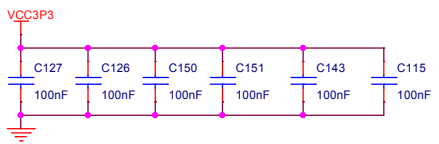

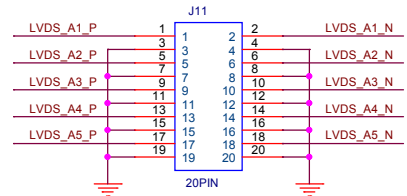

2mm间距, 无框插针, RX

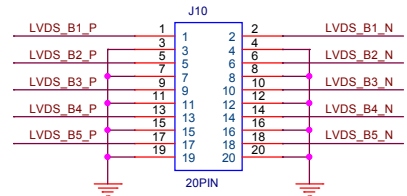

2mm间距, 无框插针, TX

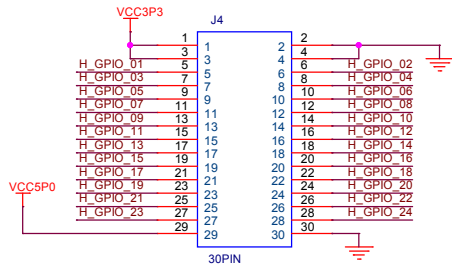

2.54mm间距, 无框插针

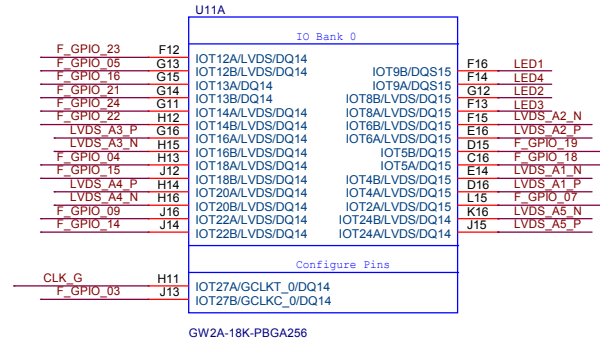
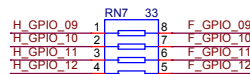
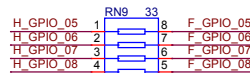
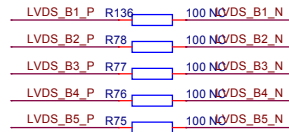
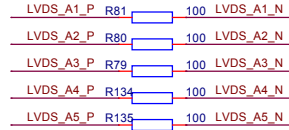
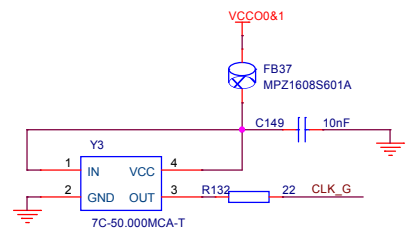

Configure Pins

CLK_G	H11	IOT27A/GCLKT_0/DQ14
F_GPIO_03	J13	IOT27B/GCLKC_0/DQ14

GW2A-18K-PBGA256

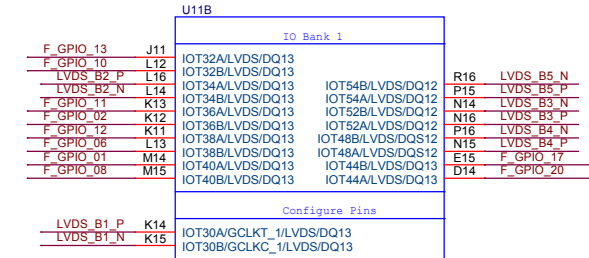

Configure Pins

LVDS_B1_P	K14	IOT30A/GCLKT_1/LVDS/DQ13
LVDS_B1_N	K15	IOT30B/GCLKC_1/LVDS/DQ13

GW2A-18K-PBGA256

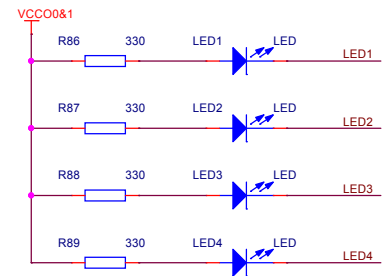
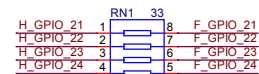
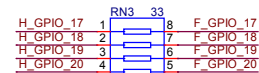
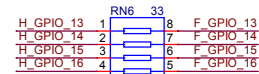

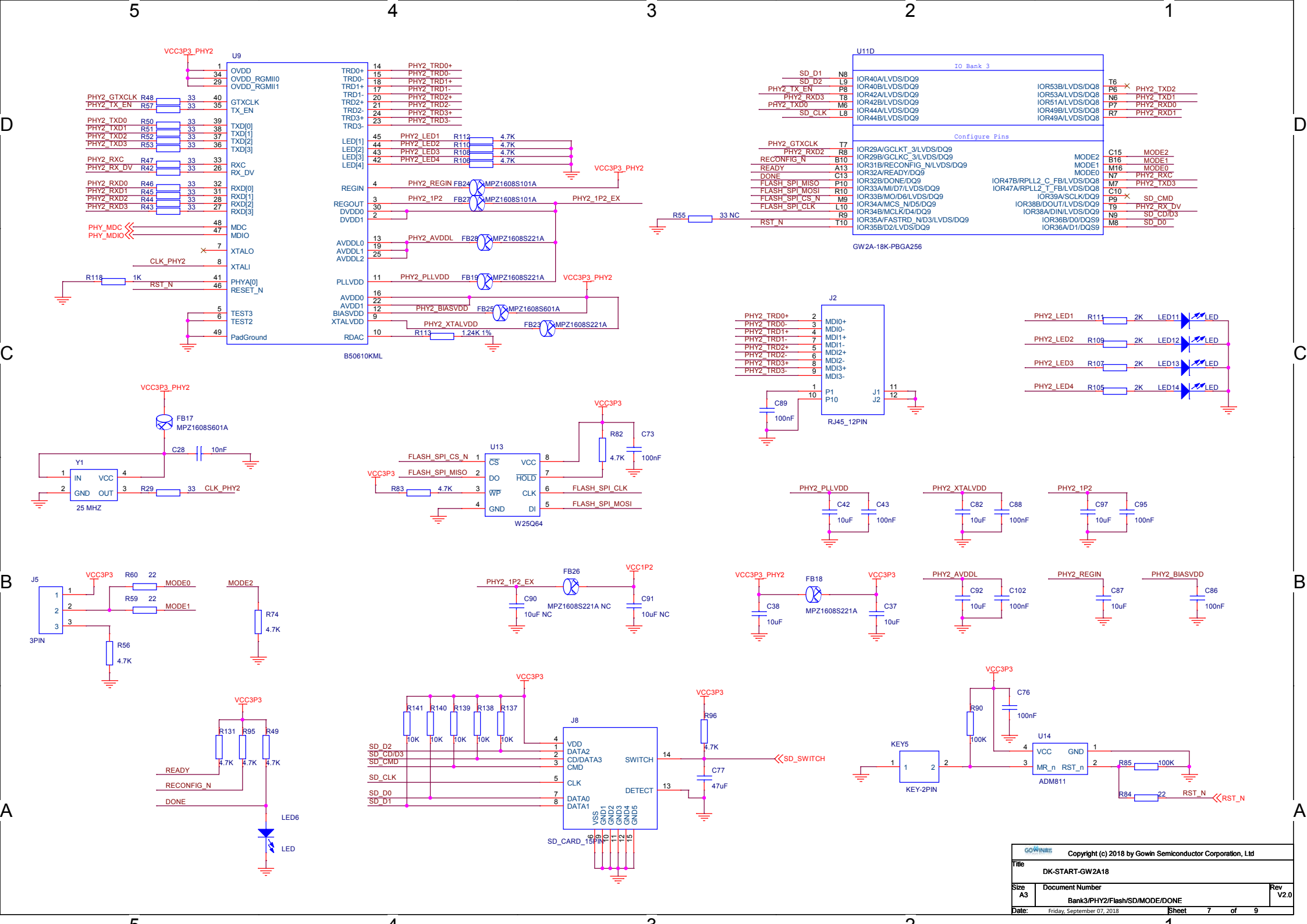

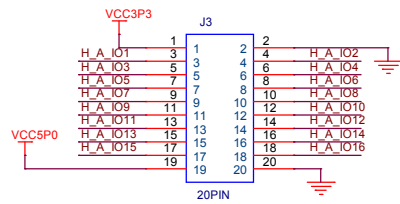

2.54mm间距，无框插针

